

## USB3 FTV Amplifier / Extender

Extend your USB3 cordset over long distances



### Description

The USB3.2 Gen1 protocol is limited to 3 meters. Our USB3.2 Gen1 amplifier allows you to extend the USB3 signal to 11 meters maximum.

We propose a standard range of amplifiers from 3 meters up to 8 meters (see How to order).

Using the USB3 amplifier selection guide below, please consider all your requirements and contact us.

### Main features

#### Main characteristics:

- An 8 meters USB3 amplifier can be connected with a 3 meters cordset to achieve a maximum length of 11 meters.
- USB3 cordset is provided by Amphenol.
- Shock, vibration and traction resistance
- Improved EMI protection
- Mate with our USB3FTV™ series (MIL-DTL-38999 series III type) with anti-decoupling device - Shell size 15

#### Environmental protection:

- Sealing (when mated): IP68 (temporary immersion)
- Salt spray:
  - 48 h - Aluminum shell with Nickel plating ✓
  - 500 h - Aluminum shell with Black zinc nickel plating ✓
  - 500 h - Aluminum shell with Olive drab cadmium plating
  - 500 h - Aluminum shell with Tin-zinc plating ✓ **NEW**
  - 500 h - Marine bronze shell ✓
- Humidity: 21 days, 43°C, 98% humidity
- Temperature range: - 40°C / + 85°C

✓: RoHS compliant

### USB3 Amplifier wiring diagram

#### ⚠ Straight wirings

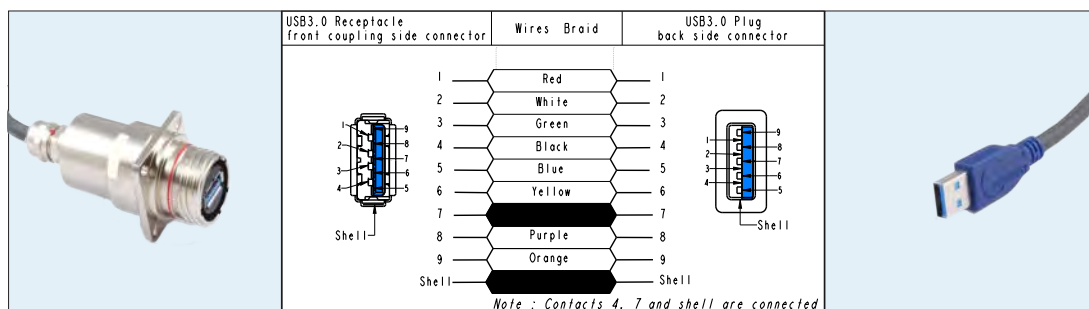

### Markets & Applications



C5ISR, Battlefield Communication



Ground Vehicles



Naval



Applications :

- Displays, Consoles, Visions systems, Situation awareness

# USB3F TV AMPLIFIER



## Available configurations

### Square flange receptacle – Shell type 2 - 4 mounting holes

Part number type: **CA USB3 FTV 2 X X XX**

**X:** see the How to order to complete your part number

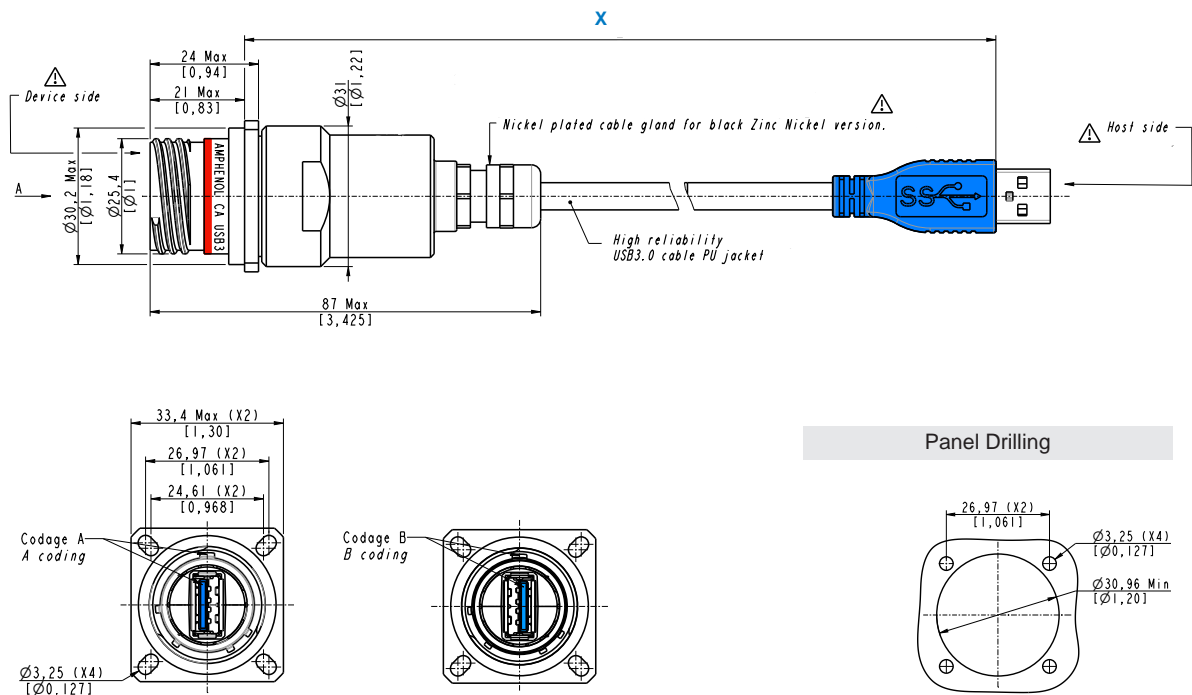

### Jam nut receptacle – Shell type 7 - Hexagonal nut mounting

Part number type: **CA USB3 FTV 7 X X XX**

**X:** see the How to order to complete your part number

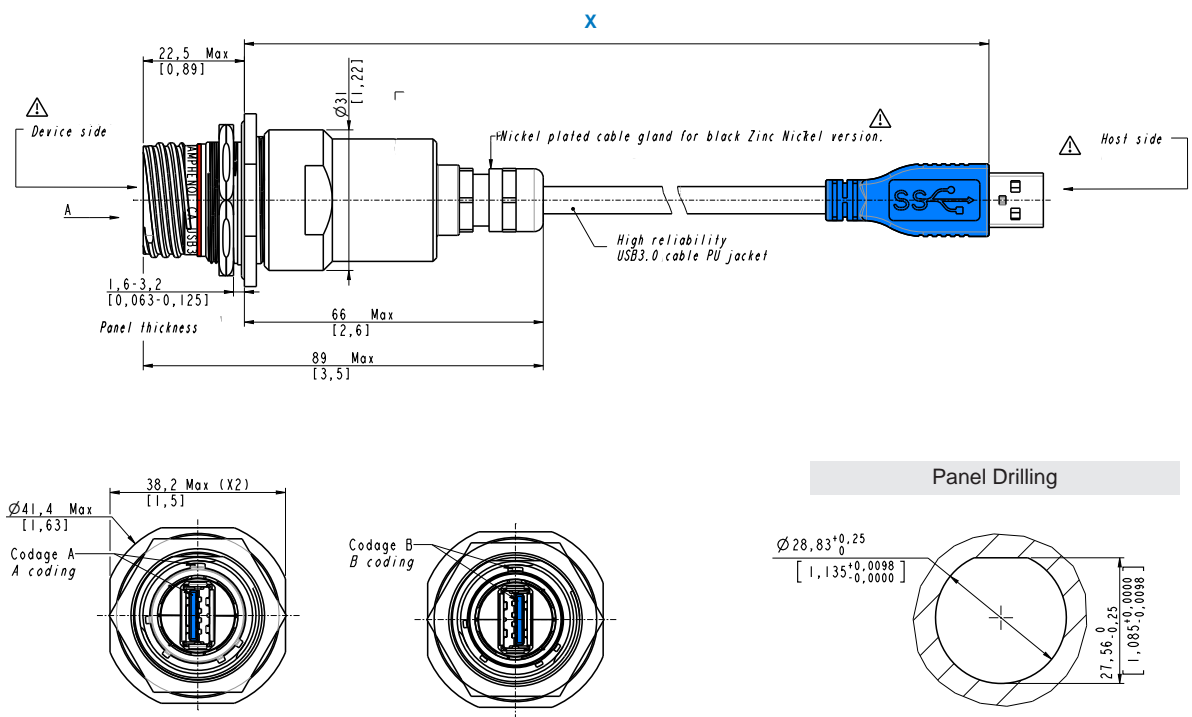

## USB3 Amplifier selection guide

Define your own solution by selecting options in the scheme below

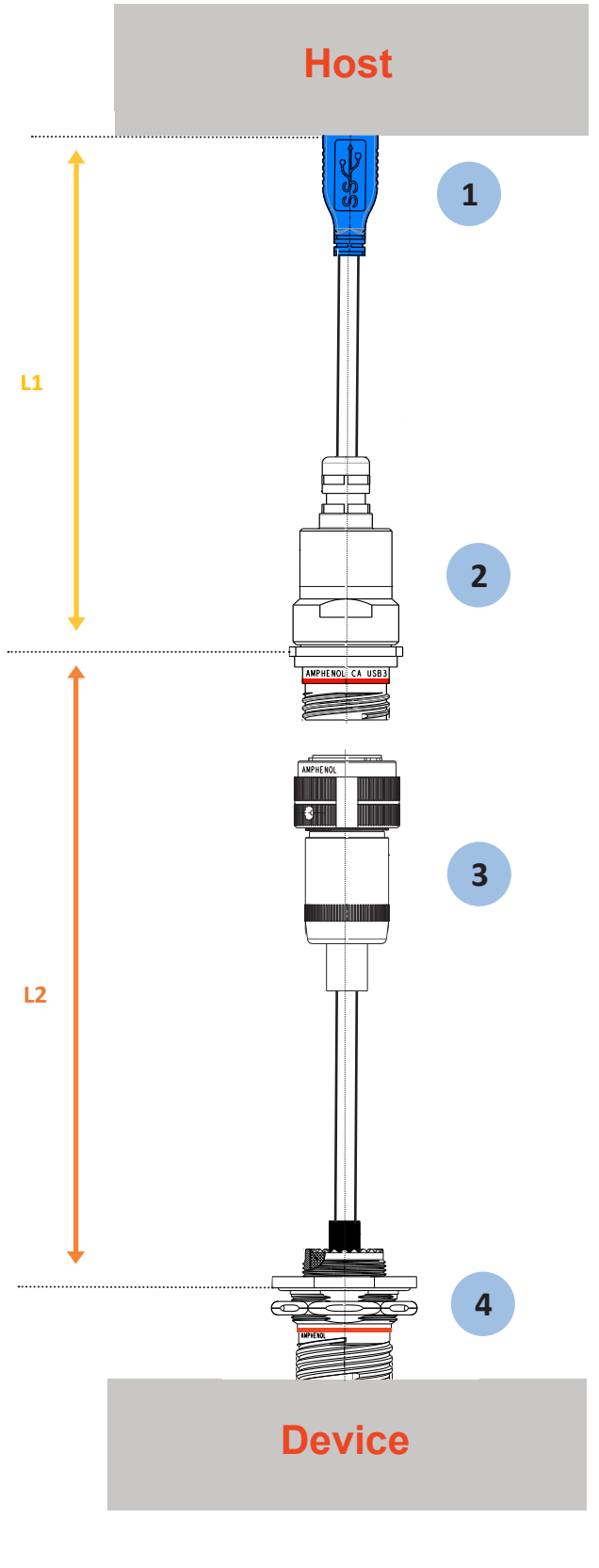

**1** Define the type of USB3 cable end:

- Standard USB3 Type A plug or USB3FTV plug.

**If you want a USB3 FTV plug:**

- Nickel plated, Olive drab cadmium plated or Black zinc nickel plated, Tin zinc plated or Marine bronze shell.
- Protective cap or not.

**L1** Define the length of L1:

- Standard lengths : 3 m, 6 m, 8 m.

**2** Define the USB3 amplifier shell:

- Square flange or jam nut receptacle.
- Nickel plated, Olive drab cadmium plated or Black zinc nickel plated, Tin zinc plated or Marine bronze shell.
- Protective cap or not.

**3** Define the type of plug:

- Standard USB3 Type A plug or USB3FTV plug.

**If you want a USB3 FTV plug:**

- Nickel plated, Olive drab cadmium plated or Black zinc nickel plated, Tin zinc plated or Marine bronze shell.
- Protective cap or not.

**L2** Define the length of L2:

- Standard lengths : 1 m, 2 m, 3 m.

**4** Define the type of USB3 cable end:

- Standard USB3 Type A plug or USB3 FTV plug.

**If you want a USB3 FTV plug:**

- Nickel plated, Olive drab cadmium plated or Black zinc nickel plated, Tin zinc plated or Marine bronze shell.
- Protective cap or not.

**If you want a USB3 FTV receptacle:**

- Square flange or jam nut receptacle.
- Female USB3 Type A or soldered cable.
- Transversally sealed for soldered cable termination or not.
- Backshell or not.
- Nickel plated, Olive drab cadmium plated or Black zinc nickel plated, Tin zinc plated or Marine bronze shell.
- Protective cap or not.

# USB3F TV AMPLIFIER

## Accessories



### Standard protective cap

This protective cap provides you with a permanent sealing.

#### Receptacle caps

Part number: **USBFTV C 2 XX**  
**USBFTV C 7 XX**

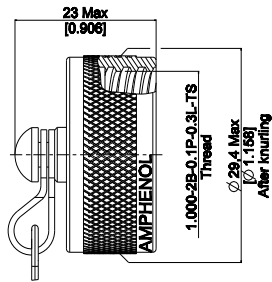

#### Attachment type

Small ring for square flange receptacle

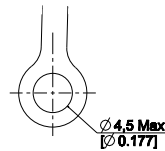

Large ring for jam nut receptacle

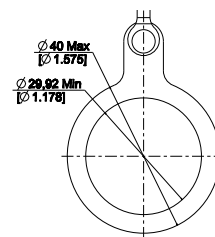

#### Rope material

Metallic chain



Stainless steel rope

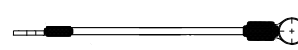

Nylon rope

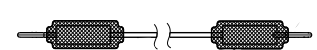

Cap type

Receptacle caps

Metallic chain length (mm)

Nylon cord length (mm)

127 (+13,-7)

Stainless steel rope length (mm)

### Metallic Self-Closing Caps

Part number: **TVSCC 17 XX**



- Only for square flange receptacle
- IP67
- Size 17

Part number

Plating

**TVSCC 17 B**

Black painted ✓

**TVSCC 17 N**

Nickel ✓

**TVSCC 17 G**

Olive drab cadmium

**TVSCC 17 ZN**

Black zinc nickel ✓

✓: RoHS compliant

### Cybersecurity solutions

Amphenol Socapex has developed a dedicated solution to prevent unauthorized access to critical interconnexions. Caplocks & Pluglocks in composite material are designed to meet this need.

Suitable part numbers for your USB3 connectors:

#### CapLock

Part number: **CapLock 15 TX**  
**CapLock 15 WR**



#### PlugLock

Part number: **PlugLock 15 TX**  
**PlugLock 15 WR**



**TX** : Torx Safety screw

**WR** : Cable seal , metal wire to cut to unlock

#### CapLock and Pluglock datasheet

Scan & discover !



# USB3F TV AMPLIFIER

## How to order - Amplifier

1.	2.	3.	4.	5.
Series	Shell type	Coding (for plug with cordset only)	Material and platings	Cordset length (for plug with cordset only)
CA USB3F TV	2	A	G	30

1. Series	
CA USB3F TV	USB3.2 Gen1 Field Series copper amplifier (USB3-A)

2. Shell type	
● 2	Square flange receptacle
7	Jam nut receptacle

3. Coding (for plug with cordset only)	
● A	Coding A
B	Coding B

4. Material and platings		
	Shell material	Shell plating
● G	Aluminum	Olive drab cadmium
N		Nickel ✓
● ZN		Black zinc nickel ✓
TZ		Tin Zinc ✓ <span style="color: red; font-weight: bold;">NEW</span>
BZ	Bronze ✓	

✓ : RoHS compliant

5. Cordset length with plug USB3 type A		
	Meters	Inch
● 30	3 m	118,11
40	4 m	157,48
50	5 m	196,85
● 60	6 m	236,22
70	7 m	275,59
● 80	8 m	314,96

● Standard configurations available from stock in our distributors network.

### Examples :

Part number	Description
CA USB3F TV 7 A ZN 80	USB3.2 Gen1 Field Series copper amplifier (USB3-A), jam nut receptacle, coding A, black zinc nickel plating, 8-meters cordset
CA USB3F TV 2 B G 60	USB3.2 Gen1 Field Series copper amplifier (USB3-A), square flange receptacle, coding B, olive drab cadmium plating, 6-meters cordset
CA USB3F TV 2 A TZ 30	USB3.2 Gen1 Field Series copper amplifier (USB3-A), square flange receptacle, coding A, tin zinc plating, 3-meters cordset

## How to order - Accessories

### Standard protective cap

1.	2.	3.	4.
Series	Connector type	Rope type	Shells material and finish
USBFTVC	7	M	G

1. Series	
USBFTVC	USBFTV standard protective cap

2. Connector type	
2	Square flange receptacle
7	Jam nut receptacle

3. Rope type	
Blank	Nylon cord
M	Metallic chain
MR	Stainless Steel rope - Transparent teflon jacket
BMR	Stainless Steel rope - Black teflon jacket for ZN finish

4. Shell material and finish	
N	Nickel plating ✓
G	Olive drab cadmium
ZN	Black zinc nickel plating ✓

✓ : RoHS compliant

